



 **日盛钢铁**
RISING STEEL SINCE 1993

PRODUCTS MANUAL

RISING STEEL SINCE 1993

产品手册



筑梦未来 日盛与您携手
Reaching the top, Rising with you

Company Introduction

公司介绍



日盛钢铁
RISING STEEL SINCE 1993

日盛钢铁

佛山市日盛钢铁贸易有限公司成立于1993年，经过二十多年的努力经营，引进现代经营管理模式，已发展成为一家集钢铁贸易、加工、配送及研发、生产工具钢、模具钢的大型民营企业。主要经营产品：H型钢、工字钢、槽钢、角钢、钢板、方矩管、圆管、钢板桩、热作模具钢H13、冷作模具钢、塑料模具钢等钢材品种。经销钢材主要来自子公司日盛特及宝钢、马钢、日照、津西、鞍钢、武钢、包钢、莱钢、冶钢等国内各大型钢厂。

Rising Trading Company

Rising Steel Trading Co, Ltd was founded in 1993 with more than 20 years experiences as steel distributor in China. Our business includes steel distribution, steel machining and logistics. Main products include steel beam, steel channel, steel angle, steel sheet, steel tube, tool steel, mold steel and etc. The product are produced by our subsidiary Rising Technology, Bao Wu Steel, Ma Steel, An Steel, Rizhao Steel, Jinxi Steel and etc.



日盛特钢

湖北日盛科技有限公司是一家专业生产中高端模具钢的民营企业，通过了ISO9001:2008质量管理体系和ISO14001环境管理体系的认证。工厂占地100,000平方米，由电炉车间、电渣车间、锻造车间、机加工车间、技术中心和职能部门组成，拥有行业内先进的生产设备如15吨电弧炉、20吨精炼炉、20吨真空炉。0.5-10吨电渣炉、1-10吨电液锤、30-40吨退火炉等大型机加工设备等，年产2.5万吨，可根据市场客户需求，定制生产超细化、电渣等高端工模具钢。日盛优质模具材料深受国内外客户的高度认可，覆盖珠三角、长三角地区，远销欧美市场。

Rising Technology Company

Hubei Rising Technology Co, Ltd is an ISO certified private mill, covers an area of 100,000sqm with annual capacity 25,000 tons. And Hubei Rising's international standard quality material is being highly approved by major stockholders in Germany, USA etc.

①Equipment: EAF(15T), LF(20T), VD(20T), electro-slag furnace(0.5-10T), annealing furnace(30T,40T), electro-hydraulic hammer(1-10T), saw machine, peeling machine, turning machine, milling machine.

②Self-testing facilities: spectrometer, sclerometer, TP-CSA of German SPECTRO MAX, portable spectrograph, metalloscope, CST defectoscope and flaw detector, sampling machine, precise lathe machine.

③Sales network: Regular stock of H13/1.2344 rounds and flats over 2000T for domestic moldmakers, widely selling to Germany, USA, Italy, Turkey, India etc, and Rising presents its quality tool steel at Euromold, Asiamold, Intermold exhibition.



H型钢

Steel H-Beam

中国标准 Chinese Standard: GB/T 11263
 材质 Grade: Q235B、Q355B(Q345B)
 标准长度 Length: 12m

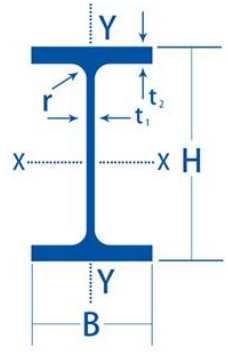

H-腹板高度
 B-翼缘宽度
 t₁-腹板厚度
 t₂-翼缘厚度
 r-圆角

类别 Designation	型号 Model Height x Width Depth x Width	截面尺寸 Size mm				截面面积 Section Area cm ²	理论重量 Mass kg/m	惯性矩 Moment of Inertia cm ⁴		惯性半径 Radius of Inertia cm		截面模数 Section Modulus cm ³	
		H x B	t ₁	t ₂	r			I _x	I _y	i _x	i _y	W _x	W _y
HN 窄翼缘H型钢	100x50	100x50*	5	7	10	12.16	9.54	192	14.9	3.98	1.11	38.5	5.96
	125x60	125x60*	6	8	10	17.01	13.3	417	29.3	4.95	1.31	66.8	9.75
	150x75	150x75	5	7	10	18.16	14.3	679	49.6	6.12	1.65	90.6	13.2
	175x90	175x90	5	8	10	23.21	18.2	1220	97.6	7.26	2.05	140	21.7
	198x99	198x99	4.5	7	13	23.59	18.5	1610	114	8.27	2.2	163	23
	200x100	200x100	5.5	8	13	27.57	21.7	1880	134	8.25	2.21	188	26.8
	250x125	248x124	5	8	13	32.89	25.8	3560	255	10.4	2.78	287	41.1
		250x125	6	9	13	37.87	29.7	4080	294	10.4	2.79	326	47
	300x150	298x149	5.5	8	16	41.55	32.6	6460	443	12.4	3.26	433	59.4
		300x150	6.5	9	16	47.53	37.3	7350	508	12.4	3.27	490	67.7
	350x175	346x174	6	9	16	53.19	41.8	11200	792	14.5	3.86	649	91
		350x175	7	11	16	63.66	50	13700	985	14.7	3.93	782	113
	400x150	400x150*	8	13	16	71.12	55.8	18800	734	16.3	3.21	942	97.9
	400x200	396x199	7	11	16	72.16	56.7	20000	1450	16.7	4.48	1010	145
		400x200	8	13	16	84.12	66	23700	1740	16.8	4.54	1190	174
	450x150	450x150*	9	14	20	83.41	65.5	27100	793	18	3.08	1200	106
	450x200	446x199	8	12	20	84.95	66.7	29000	1580	18.5	4.31	1300	159
		450x200	9	14	20	97.41	76.5	33700	1870	18.6	4.38	1500	187
	500x150	500x150*	10	16	20	98.23	77.1	38500	907	19.8	3.04	1540	121
		496x199	9	14	20	101.3	79.5	41900	1840	20.3	4.27	1690	185
500x200	500x200	10	16	20	114.2	89.6	47800	2140	20.5	4.33	1910	214	
	506x201*	11	19	20	131.3	103	56500	2580	20.8	4.43	2230	257	
600x200	596x199	10	15	24	121.2	95.1	69300	1980	23.9	4.04	2330	199	
	600x200	11	17	24	135.2	106	78200	2280	24.1	4.11	2610	228	
606x201*	606x201*	12	20	24	153.3	120	91000	2720	24.4	4.21	3000	271	
	692x300	13	20	28	211.5	166	172000	9020	28.6	6.53	4980	602	
700x300	700x300	13	24	28	235.5	185	201000	10800	29.3	6.78	5760	722	
	792x300*	14	22	28	243.4	191	254000	9930	32.3	6.39	6400	662	
800x300	800x300	14	26	28	267.4	210	292000	11700	33	6.62	7290	782	
	890x299*	15	23	28	270.9	213	345000	10300	35.7	6.16	7760	688	
900x300	900x300	16	28	28	309.8	243	411000	12600	36.4	6.39	9140	843	
912x302*	912x302*	18	34	28	364	286	498000	15700	37	6.56	10900	1040	
	148x100	6	9	13	27.25	21.4	1040	151	6.17	2.35	140	30.2	
HM 中翼缘H型钢	200x150	194x150	6	9	16	39.76	31.2	2740	508	8.3	3.57	283	67.7
	250x175	244x175	7	11	16	56.24	44.1	6120	985	10.4	4.18	502	113
	300x200	294x200	8	12	20	73.03	57.3	11400	1600	12.5	4.69	779	160
	350x250	340x250	9	14	20	101.5	79.7	21700	3650	14.6	6	1280	292
	400x300	390x300	10	16	24	136.7	107	38900	7210	16.9	7.26	2000	481
	450x300	440x300	11	18	24	157.4	124	56100	8110	18.9	7.18	2550	541
	500x300	482x300	11	15	28	146.4	115	60800	6770	20.4	6.8	2520	451
		488x300	11	18	28	164.4	129	71400	8120	20.8	7.03	2930	541
	600x300	582x300	12	17	28	174.5	137	103000	7670	24.3	6.63	3530	511
		588x300	12	20	28	192.5	151	118000	9020	24.8	6.85	4020	601
594x302*	14	23	28	222.4	175	137000	10600	24.9	6.9	4620	701		
HW 宽翼缘H型钢	100x100	100x100	6	8	10	21.9	17.2	383	134	4.18	2.47	76.5	26.7
	125x125	125x125	6.5	9	10	30.31	23.8	847	294	5.29	3.11	136	47
	150x150	150x150	7	10	13	40.55	31.9	1660	564	6.39	3.73	221	75.1
	175x175	175x175	7.5	11	13	51.43	40.3	2900	984	7.5	4.37	331	112
	200x200	200x200	8	12	16	64.28	50.5	4770	1600	8.61	4.99	477	160
		200x204	12	12	16	72.28	56.7	5030	1700	8.35	4.85	503	167
	250x250	250x250	9	14	16	92.18	72.4	10800	3650	10.8	6.29	867	292
		250x255	14	14	16	104.7	82.2	11500	3880	10.5	6.09	919	304
	294x302*	294x302*	12	12	20	108.3	85	17000	5520	12.5	7.14	1160	365
		300x300	10	15	20	120.4	94.5	20500	6760	13.1	7.49	1370	450
	300x305	300x305	15	15	20	135.4	106	21600	7100	12.6	7.24	1440	466
		344x348*	10	16	20	146	115	33300	11200	15.1	8.78	1940	646
	350x350	350x350	12	19	20	173.9	137	40300	13600	15.2	8.84	2300	776
		388x402*	15	15	24	179.2	141	49200	16300	16.6	9.52	2540	809
	394x398*	394x398*	11	18	24	187.6	147	56400	18900	17.3	10	2860	951
		400x400	13	21	24	219.5	172	66900	22400	17.5	10.1	3340	1120
	400x408	400x408	21	21	24	251.5	197	71100	23800	16.8	9.73	3560	1170
		414x405*	18	28	24	296.2	233	93000	31000	17.7	10.2	4490	1530
428x407*	20	35	24	361.4	284	119000	39400	18.2	10.4	5580	1930		
458x417*	30	50	24	529.3	415	187000	60500	18.8	10.7	8180	2900		
498x432*	45	70	24	770.8	605	298000	94400	19.7	11.1	12000	4370		

注1: 可通过“日盛钢铁”官方网站www.rising-steel.com或官方微信小程序了解产品详情及价格走势。
 注2: 表中“*”表示的规格为非常规尺寸, 价格可能较高
 注3: 表中同一型号的产品, 其内侧尺寸高度一致。
 注4: 表中截面面积计算公式为: t₁(H-2t₂)+2Bt₂+0.858r²。



工字钢

Steel I-Beam

中国标准 Chinese Standard: GB/T 706
材质 Grade: Q235B
标准长度 Length: 6m/12m

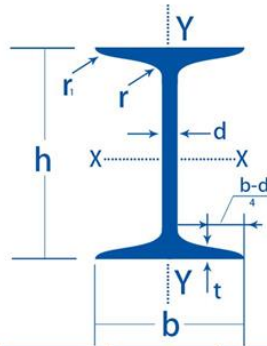

h-高度
b-腿宽度
d-腰厚度
t-平均腿厚度
r-内圆弧半径
r1-腿端圆弧半径

型号 Designation	截面尺寸 Size mm						截面面积 Section Area cm ²	理论重量 Mass kg/m	惯性矩 Moment of Inertia cm ⁴		惯性半径 Radius of Inertia cm		截面模数 Section Modulus cm ³	
	h	b	d	t	r	r1			Ix	Iy	ix	iy	Wx	Wy
10	100	68	4.5	7.6	6.5	3.4	14.345	11.261	245	33	4.14	1.52	49	9.72
12	120	74	5	8.4	7	3.5	17.818	13.987	436	46.9	4.95	1.62	72.7	12.7
14	140	80	5.5	9.1	7.5	3.8	21.516	16.89	712	64.4	5.76	1.73	102	16.1
16	160	88	6	9.9	8	4	26.131	20.513	1130	93.1	6.58	1.89	141	21.2
18	180	94	6.5	10.7	8.5	4.3	30.756	24.143	1660	122	7.36	2	185	26
20a	200	100	7	11.4	9	4.5	35.578	27.929	2370	158	8.15	2.12	237	31.5
20b	200	102	9	11.4	9	4.5	39.578	31.069	2500	169	7.96	2.06	250	33.1
22a	220	110	7.5	12.3	9.5	4.8	42.128	33.07	3400	225	8.99	2.31	309	40.9
22b	220	112	9.5	12.3	9.5	4.8	46.528	36.524	3570	239	8.78	2.27	325	42.7
25a	250	116	8	13	10	5	48.541	38.105	5020	280	10.2	2.4	402	48.3
25b	250	118	10	13	10	5	53.541	42.03	5280	309	9.94	2.4	423	52.4
28a	280	122	8.5	13.7	10.5	5.3	55.404	43.492	7110	345	11.3	2.5	508	56.6
28b	280	124	10.5	13.7	10.5	5.3	61.004	47.888	7480	379	11.1	2.49	534	61.2
30a	300	126	9	14.4	11	5.5	61.254	48.084	8950	400	12.1	2.55	597	63.5
30b	300	128	11	14.4	11	5.5	67.254	52.794	9400	422	11.8	2.5	627	65.9
30特	300	128	12	20	12	5.5	82.4	64.58	11800	704	12	2.92	787	110
32a	320	130	9.5	15	11.5	5.8	67.156	52.717	11100	460	12.8	2.62	692	70.8
32b	320	132	11.5	15	11.5	5.8	73.556	57.741	11600	502	12.6	2.61	726	76
36a	360	136	10	15.8	12	6	76.48	60.037	15800	552	14.4	2.69	875	81.2
36b	360	138	12	15.8	12	6	83.68	65.689	16500	582	14.1	2.64	919	84.3
40a	400	142	10.5	16.5	12.5	6.3	86.112	67.598	21700	660	15.9	2.77	1090	93.2
40b	400	144	12.5	16.5	12.5	6.3	94.112	73.878	22800	692	15.6	2.71	1140	96.2
45a	450	150	11.5	18	13.5	6.8	102.446	80.42	22200	855	17.7	2.89	1430	114
45b	450	152	13.5	18	13.5	6.8	111.446	87.485	33800	894	17.4	2.84	1500	118
56a	560	166	12.5	21	14.5	7.3	135.435	106.316	65600	1370	22	3.18	2340	165
56b	560	168	14.5	21	14.5	7.3	146.635	115.108	68500	1490	21.6	3.16	2450	174
63a	630	176	13	22	15	7.5	154.658	121.407	93900	1700	24.5	3.31	2980	193
63b	630	178	15	22	15	7.5	167.258	131.298	98100	1810	24.2	3.29	3160	204
12.6*	126	74	5	8.4	7	3.5	18.118	14.223	488	46.9	5.2	1.61	77.5	12.7
24a*	240	116	8	13	10	5	47.741	37.477	4570	280	9.77	2.42	381	48.4
24b*	240	118	10	13	10	5	52.541	41.245	4800	297	9.57	2.38	400	50.4
27a*	270	122	8.5	13.7	10.5	5.3	54.554	42.825	6550	345	10.9	2.51	485	56.6
27b*	270	124	10.5	13.7	10.5	5.3	59.954	47.064	6870	366	10.7	2.47	509	58.9
30c*	300	130	13	14.4	11	5.5	73.254	57.504	9850	445	11.6	2.46	657	68.5
32c*	320	134	13.5	15	11.5	5.8	79.956	62.765	12200	544	12.3	2.61	760	81.2
36c*	360	140	14	15.8	12	6	90.88	71.341	17300	612	13.8	2.6	962	87.4
40c*	400	146	14.5	16.5	12.5	6.3	102.112	80.158	23900	727	15.2	2.65	1190	99.6
45c*	450	154	15.5	18	13.5	6.8	120.446	94.55	35300	938	17.1	2.79	1570	122
50a*	500	158	12	20	14	7	119.304	93.654	46500	1120	19.7	3.07	1860	142
50b*	500	160	14	20	14	7	129.304	101.504	48600	1170	19.4	3.01	1940	146
50c*	500	162	16	20	14	7	139.304	109.354	50600	1220	19	2.96	2080	151
55a*	550	168	12.5	21	14.5	7.3	134.185	105.335	62900	1370	21.6	3.19	2290	164
55b*	550	168	14.5	21	14.5	7.3	145.185	113.97	65600	1420	21.2	3.14	2390	170
55c*	550	170	16.5	21	14.5	7.3	156.185	122.605	68400	1480	20.9	3.08	2490	175
56c*	560	170	16.5	21	14.5	7.3	157.835	123.9	71400	1560	21.3	3.16	2550	183
63c*	630	180	17	22	15	7.5	179.858	141.189	102000	1920	23.8	3.27	3300	214

注1: 可通过“日盛钢铁”官方网站www.rising-steel.com或官方微信小程序了解产品详情及价格走势。
注2: 表中“*”表示的规格为非常规尺寸, 价格可能较高



槽钢 Steel Channel

中国标准 Chinese Standard: GB/T 706
材质 Grade: Q235B
标准长度 Length: 6m/12m

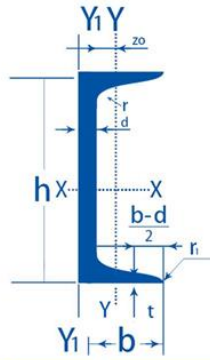

h-高度
b-腿宽度
d-腰厚度
t-平均腿厚度
r-内圆弧半径
r1-腿端圆弧半径
z0-yy轴与y1y1轴间距离

型号 Designation	截面尺寸 Size mm						截面面积 Section Area cm ²	理论重量 Mass kg/m	惯性矩 Moment of Inertia cm ⁴		惯性半径 Radius of Inertia cm		截面模数 Section Modulus cm ³		重心 距离 Centroid Z0 cm
	h	b	d	t	r	r1			Ix	Iy	ix	iy	Wx	Wy	
5	50	37	4.5	7	7	3.5	6.928	5.438	26	8.3	1.94	1.1	10.4	3.55	1.35
6.3	63	40	4.8	7.5	7.5	3.8	8.451	6.634	50.8	11.9	2.45	1.19	16.1	4.5	1.36
8	80	43	5	8	8	4	10.248	8.045	101	16.6	3.15	1.27	25.3	5.79	1.43
10	100	48	5.3	8.5	8.5	4.2	12.748	10.007	198	25.6	3.95	1.41	39.7	7.8	1.52
12	120	53	5.5	9	9	4.5	15.362	12.059	346	37.4	4.75	1.56	57.7	10.2	1.62
14a	140	58	6	9.5	9.5	4.8	18.516	14.535	564	53.2	5.52	1.7	80.5	13	1.71
14b	140	60	8	9.5	9.5	4.8	21.316	16.733	609	61.1	5.35	1.69	87.1	14.1	1.67
16a	160	63	6.5	10	10	5	21.962	17.24	866	73.3	5.28	1.83	108	16.3	1.8
16b	160	65	8.5	10	10	5	25.162	19.752	935	83.4	6.1	1.82	117	17.6	1.75
18a	180	68	7	10.5	10.5	5.2	25.699	20.174	1270	98.6	7.04	1.96	141	20	1.88
18b	180	70	9	10.5	10.5	5.2	29.299	23	1370	111	6.84	1.95	152	21.5	1.84
20a	200	73	7	11	11	5.5	28.837	22.637	1780	128	7.86	2.11	178	24.2	2.01
20b	200	75	9	11	11	5.5	32.837	25.777	1910	144	7.64	2.09	191	25.9	1.95
22a	220	77	7	11.5	11.5	5.8	31.846	24.999	2390	158	8.67	2.23	218	28.2	2.1
22b	220	79	9	11.5	11.5	5.8	36.246	28.453	2570	176	8.42	2.21	234	30.1	2.03
25a	250	78	7	12	12	6	34.917	27.41	3370	176	9.82	2.24	270	30.6	2.07
25b	250	80	9	12	12	6	39.917	31.335	3530	196	9.41	2.22	282	32.7	1.98
28a	280	82	7.5	12.5	12.5	6.2	40.034	31.427	4760	218	10.9	2.33	340	35.7	2.1
28b	280	84	9.5	12.5	12.5	6.2	45.634	35.823	5130	242	10.6	2.3	366	37.9	2.02
30a	300	85	7.5	13.5	13.5	6.8	43.902	34.463	6050	260	11.7	2.38	403	41.1	2.17
30b	300	87	9.5	13.5	13.5	6.8	49.902	39.173	6500	289	11.4	2.38	433	44	2.13
32a	320	88	8	14	14	7	48.513	38.083	7600	305	12.5	2.5	475	46.5	2.24
32b	320	90	10	14	14	7	54.913	43.107	8140	336	12.2	2.47	509	49.2	2.16
36a	360	96	9	16	16	8	60.91	47.814	11900	455	14	2.73	660	63.5	2.44
36b	360	98	11	16	16	8	68.11	53.466	12700	497	13.6	2.7	703	66.9	2.37
40a	400	100	10.5	18	18	9	75.068	58.928	17600	592	15.3	2.81	879	78.8	2.49
40b	400	102	12.5	18	18	9	83.068	65.208	18600	640	15	2.78	932	82.5	2.44
12.6*	126	53	5.5	9	9	4.5	15.692	12.318	391	38	4.95	1.57	62.1	10.2	1.59
25c*	250	82	11	12	12	6	44.917	35.26	3690	218	9.07	2.21	295	35.9	1.92
28c*	280	86	11.5	12.5	12.5	6.2	51.234	40.219	5500	268	10.4	2.29	393	40.3	1.95
30c*	300	89	11.5	13.5	13.5	6.8	55.902	43.883	6950	316	11.2	2.38	463	46.4	2.09
32c*	320	92	12	14	14	7	61.313	48.131	8690	374	11.9	2.47	543	52.6	2.09
36c*	360	100	13	16	16	8	73.31	59.118	13400	536	13.4	2.67	746	70	2.34
40c*	400	104	14.5	18	18	9	91.068	71.488	19700	688	14.7	2.78	986	86.2	2.42

注1: 可通过“日盛钢铁”官方网站www.rising-steel.com或官方微信小程序了解产品详情及价格走势。
注2: 表中“*”表示的规格为非常规尺寸, 价格可能较高

等边角钢

Steel Equal-Angle

中国标准 Chinese Standard: GB/T 706
 材质 Grade: Q235B、Q355B(Q345B)
 标准长度 Length: 6m/12m

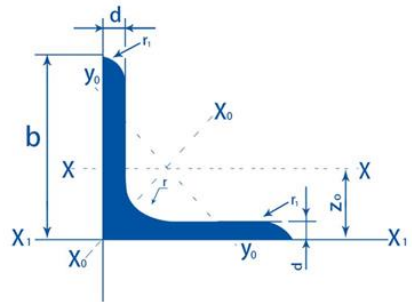

b-短边宽度
 d-边厚度
 r-内圆弧半径
 r1-边端圆弧半径

型号 Designation	截面尺寸 Size mm			截面面积 Section Area cm ²	理论重量 Mass kg/m	外表面积 Surface Area m ² /m	惯性矩 Moment of Inertia cm ⁴				惯性半径 Radius of Inertia cm			截面模数 Section Modulus cm ³			重心 距离 Z ₀ cm
	b	d	r				I _x	I _{x1}	I _y	I _{y1}	i _x	i _{x0}	i _{y0}	W _x	W _{x0}	W _{y0}	
25x25	25	3	3.5	1.432	1.124	0.098	0.82	1.57	1.29	0.34	0.76	0.95	0.49	0.46	0.73	0.33	0.73
		4	4.5	2.276	1.786	0.117	1.46	2.71	2.31	0.61	0.91	1.15	0.59	0.68	1.09	0.51	0.85
30x30	30	3	5	2.359	1.852	0.157	3.59	6.41	5.69	1.49	1.23	1.55	0.79	1.23	2.01	0.96	1.09
		4	5	3.086	2.422	0.157	4.6	8.56	7.29	1.91	1.22	1.54	0.79	1.6	2.58	1.19	1.13
40x40	40	5	5	3.791	2.976	0.156	5.53	10.74	8.76	2.3	1.21	1.52	0.78	1.96	3.1	1.39	1.17
		5	5	4.292	3.369	0.176	8.04	15.2	12.74	3.33	1.37	1.72	0.88	2.51	4	1.81	1.3
45x45	45	4	5.5	3.897	3.059	0.197	9.26	16.69	14.7	3.82	1.54	1.94	0.99	2.56	4.16	1.96	1.38
		5	5.5	4.803	3.77	0.196	11.21	20.9	17.79	4.64	1.53	1.92	0.98	3.13	5.03	2.31	1.42
50x50	50	6	5.5	5.688	4.465	0.196	13.05	25.14	20.68	5.42	1.52	1.91	0.98	3.68	5.85	2.63	1.46
		5	6.5	5.829	4.576	0.236	19.89	36.05	31.57	8.21	1.85	2.33	1.19	4.59	7.44	3.48	1.67
60x60	60	6	6.5	6.914	5.427	0.235	23.25	43.33	36.89	9.6	1.83	2.31	1.18	5.41	8.7	3.98	1.7
		7	6.5	7.977	6.262	0.235	26.44	50.65	41.92	10.96	1.82	2.29	1.17	6.21	9.88	4.45	1.74
63x63	63	8	6.5	9.02	7.081	0.235	29.47	58.02	46.66	12.28	1.81	2.27	1.17	6.98	11	4.88	1.78
		5	7	6.143	4.822	0.248	23.17	41.73	36.77	9.57	1.94	2.45	1.25	5.08	8.25	3.9	1.74
70x70	70	6	7	7.288	5.721	0.247	27.12	50.14	43.03	11.2	1.93	2.43	1.24	6	9.66	4.46	1.78
		7	7	8.412	6.603	0.247	30.87	58.6	48.96	12.79	1.92	2.41	1.23	6.88	10.99	4.98	1.82
75x75	75	8	7	9.515	7.469	0.247	34.46	67.11	54.56	14.33	1.9	2.4	1.23	7.75	12.25	5.47	1.85
		5	8	6.875	5.397	0.275	32.21	57.21	51.08	13.31	2.16	2.73	1.39	6.32	10.32	4.95	1.91
80x80	80	6	8	8.16	6.406	0.275	37.77	68.73	59.93	15.61	2.15	2.71	1.38	7.48	12.11	5.67	1.95
		7	8	9.424	7.398	0.275	43.09	80.29	68.35	17.82	2.14	2.69	1.38	8.59	13.81	6.34	1.99
85x85	85	8	8	10.667	8.373	0.274	48.17	91.92	76.37	19.98	2.12	2.68	1.37	9.68	15.43	6.98	2.03
		5	9	7.412	5.818	0.295	39.97	70.56	63.3	16.63	2.33	2.92	1.5	7.32	11.94	5.77	2.04
90x90	90	6	9	8.797	6.905	0.294	46.95	84.55	74.38	19.51	2.31	2.9	1.49	8.64	14.02	6.67	2.07
		7	9	10.16	7.976	0.294	53.57	98.71	84.96	22.18	2.3	2.89	1.48	9.93	16.02	7.44	2.11
95x95	95	8	9	11.503	9.03	0.294	59.96	112.97	95.07	24.86	2.28	2.88	1.47	11.2	17.93	8.19	2.15
		9	9	12.825	10.068	0.294	66.1	127.3	104.71	27.48	2.27	2.86	1.46	12.43	19.75	8.89	2.18
100x100	100	10	9	14.126	11.089	0.293	71.98	141.71	113.92	30.05	2.26	2.84	1.46	13.64	21.48	9.56	2.22
		5	9	7.912	6.211	0.315	48.79	85.36	77.33	20.25	2.48	3.13	1.6	8.34	13.67	6.66	2.15
105x105	105	6	9	9.397	7.376	0.314	57.35	102.5	90.98	23.72	2.47	3.11	1.59	9.87	16.08	7.65	2.19
		7	9	10.86	8.525	0.314	65.58	119.7	104.07	27.09	2.46	3.1	1.58	11.37	18.4	8.58	2.23
110x110	110	8	9	12.303	9.658	0.314	73.49	136.97	116.6	30.39	2.44	3.08	1.57	12.83	20.61	9.46	2.27
		9	9	13.725	10.774	0.314	81.11	154.31	128.6	33.61	2.43	3.06	1.56	14.25	22.73	10.29	2.31
115x115	115	10	9	15.126	11.874	0.313	88.43	171.74	140.09	36.77	2.42	3.04	1.56	15.64	24.76	11.08	2.35
		6	10	10.637	8.35	0.354	82.77	145.87	131.26	34.28	2.79	3.51	1.8	12.61	20.63	9.95	2.44
120x120	120	7	10	12.301	9.656	0.354	94.83	170.3	150.47	39.18	2.78	3.5	1.78	14.54	23.64	11.19	2.48
		8	10	13.944	10.946	0.353	106.47	194.8	168.97	43.97	2.76	3.48	1.78	16.42	26.55	12.35	2.52
125x125	125	9	10	15.566	12.219	0.353	117.72	219.39	186.77	48.66	2.75	3.46	1.77	18.27	29.35	13.46	2.56
		10	10	17.167	13.476	0.353	128.58	244.07	203.9	53.26	2.74	3.45	1.76	20.07	32.04	14.52	2.59
130x130	130	6	12	11.932	9.366	0.393	114.95	200.07	181.98	47.92	3.1	3.9	2	15.68	25.74	12.69	2.67
		7	12	13.796	10.83	0.393	131.86	233.54	208.97	54.74	3.09	3.89	1.99	18.1	29.55	14.26	2.71
140x140	140	8	12	15.638	12.276	0.393	148.24	267.09	235.07	61.41	3.08	3.88	1.98	20.47	33.24	15.75	2.76
		9	12	17.462	13.708	0.392	164.12	300.73	260.3	67.95	3.07	3.86	1.97	22.79	36.81	17.18	2.8
150x150	150	10	12	19.261	15.12	0.392	179.51	334.48	284.68	74.35	3.05	3.84	1.96	25.06	40.26	18.54	2.84
		12	12	22.8	17.898	0.391	208.9	402.34	330.95	86.84	3.03	3.81	1.95	29.48	46.8	21.08	2.91
160x160	160	8	12	17.238	13.535	0.433	199.46	355.2	316.49	82.42	3.4	4.28	2.19	24.95	40.69	19.39	3.01
		10	12	21.261	16.69	0.432	242.19	444.65	384.39	99.98	3.38	4.25	2.17	30.6	49.42	22.91	3.09
170x170	170	12	12	25.2	19.782	0.431	282.55	534.6	448.17	116.93	3.35	4.22	2.15	36.05	57.62	26.15	3.16
		8	14	19.75	15.504	0.492	297.03	521.01	470.89	123.16	3.88	4.88	2.5	32.52	53.28	25.86	3.37
175x175	175	10	14	24.373	19.133	0.491	361.67	651.93	573.89	149.46	3.85	4.85	2.48	39.97	64.93	30.62	3.45
		12	14	28.912	22.696	0.491	423.16	783.42	671.44	174.88	3.83	4.82	2.46	41.17	75.96	35.03	3.53
180x180	180	10	14	27.373	21.488	0.551	514.65	915.11	817.27	212.04	4.34	5.46	2.78	50.58	82.56	39.2	3.82
		12	14	32.512	25.522	0.551	603.68	1099.28	958.79	248.57	4.31	5.43	2.76	59.8	96.85	45.02	3.9
190x190	190	14	14	37.567	29.49	0.55	688.81	1284.22	1093.56	284.05	4.28	5.4	2.75	58.75	110.47	50.45	3.98
		10	16	31.502	24.729	0.63	779.53	1365.33	1237.3	321.76	4.98	6.27	3.2	66.7	109.36	52.76	4.31
200x200	200	12	16	37.441	29.391	0.63	916.58	1639.57	1455.68	377.49	4.95	6.24	3.18	78.98	128.67	60.74	4.39
		14	16	43.296	33.987	0.629	1048.36	1914.68	1665.02	431.7	4.92	6.2	3.16	90.95	147.17	68.24	4.47
210x210	210	16	16	49.067	38.518	0.629	1175.08	2190.82	1865.57	484.59	4.89	6.17	3.14	102.63	164.89	75.31	4.55
		14	16	48.896	38.383	0.709	1514.48	2723.48	2407.42	621.53	5.56	7.02	3.56	116.25	189.14	88.38	4.97
220x220	220	16	16	55.467	43.542	0.709	1700.99	3115.29	2703.37	698.6	5.54	6.98	3.55	131.13	212.4	97.83	5.05
		18	16	61.055	48.634	0.708	1875.12	3502.43	2988.24	762.01	5.5	6.94	3.51	145.64	234.78	106.14	5.13
230x230	230	14	18	54.642	42.894	0.788	2103.55	3734.1	3343.26	863.83	5.2	7.82	3.98	144.7	236.4	111.82	5.46
		16	18	62.013	48.68	0.788	2366.15	4270.39	3760.89	971.41	6.18	7.79	3.96	163.65	265.93	123.96	5.54
240x240	240	18	18	69.301	54.401	0.787	2620.64	4808.13	4164.54	1076.74	6.15	7.75	3.94	182.22	294.48	135.52	5.62
		20	18	76.505	60.056	0.787	2867.3	5347.51	4554.55	1180.04	6.12	7.72	3.93	200.42	322.06	146.55	5.69
250x250	250	24	18	90.661	71.168	0.785	3338.25	6457.16	5294.97	1381.53	6.07	7.64	3.9	236.17	374.41	166.65	5.87

注1: 可通过“日盛钢铁”官方网站www.rising-steel.com或官方微信小程序了解产品详情及价格走势。

不等边角钢

Steel Unequal-Angle

中国标准 Chinese Standard: GB/T 706
 材质 Grade: Q235B、Q355B(Q345B)
 标准长度 Length: 6m/12m

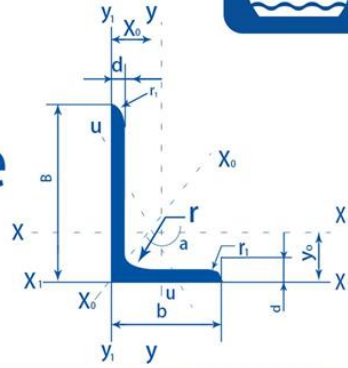

B-长边宽度
 b-短边宽度
 d-边厚度
 r-内圆弧半径
 r1-边端圆弧半径
 x0-重心距离
 y0-重心距离

型号 Designation	截面尺寸 Size/mm				截面面积 Section Area cm ²	理论重量 Mass kg/m	外表面积 Surface Area m ² /m	惯性矩 Moment of Inertia cm ⁴					惯性半径 Radius of Inertia cm			截面模数 Section Modulus cm ³			tan α	重心距离 Centroid cm			
	B	b	d	r				I _x	I _{x1}	I _y	I _{y1}	I _u	i _x	i _{y0}	i _u	W _x	W _y	W _u		X ₀	Y ₀		
25x16	25	16	3		1.162	0.912	0.08	0.7	1.56	0.22	0.43	0.14	0.78	0.44	0.34	0.43	0.19	0.16	0.392	0.42	0.86		
			4		1.499	1.176	0.079	0.88	2.09	0.27	0.59	0.17	0.77	0.43	0.34	0.55	0.24	0.2	0.381	0.46	0.9		
32x20	32	20	3	3.5	1.492	1.171	0.102	1.53	3.27	0.46	0.82	0.28	1.01	0.55	0.43	0.72	0.3	0.25	0.382	0.49	1.08		
			4		1.939	1.522	0.101	1.93	4.37	0.57	1.12	0.35	1	0.54	0.42	0.93	0.39	0.32	0.374	0.53	1.12		
40x25	40	25	3	4	1.89	1.484	0.127	3.08	5.39	0.93	1.59	0.56	1.28	0.7	0.54	1.15	0.49	0.4	0.385	0.59	1.32		
			4		2.467	1.936	0.127	3.93	8.53	1.18	2.14	0.71	1.36	0.69	0.54	1.49	0.63	0.52	0.381	0.63	1.37		
45x28	45	28	3	5	2.149	1.637	0.143	4.45	9.1	1.34	2.23	0.8	1.44	0.79	0.61	1.47	0.62	0.51	0.383	0.64	1.47		
			4		2.806	2.203	0.143	5.69	12.1	1.7	3	1.02	1.42	0.78	0.6	1.91	0.8	0.66	0.38	0.68	1.51		
50x32	50	32	3	5.5	2.431	1.908	0.161	6.24	12.5	2.02	3.31	1.2	1.6	0.91	0.7	1.84	0.82	0.68	0.404	0.73	1.6		
			4		3.177	2.494	0.16	8.02	16.7	2.58	4.45	1.53	1.59	0.9	0.69	2.39	1.06	0.87	0.402	0.77	1.65		
56x36	56	36	3	6	2.743	2.153	0.181	8.88	17.5	2.92	4.7	1.73	1.8	1.03	0.79	2.32	1.05	0.87	0.408	0.8	1.78		
			4		3.59	2.818	0.18	11.5	23.4	3.76	6.33	2.23	1.79	1.02	0.79	3.03	1.37	1.13	0.408	0.85	1.82		
63x40	63	40	5	7	4.415	3.466	0.18	13.9	29.3	4.49	7.94	2.67	1.77	1.01	0.78	3.71	1.65	1.36	0.404	0.88	1.87		
			4		4.058	3.185	0.202	16.5	33.3	5.23	8.63	3.12	2.02	1.14	0.88	3.87	1.7	1.4	0.398	0.92	2.04		
70x45	70	45	5	7	4.993	3.92	0.202	20	41.6	6.31	10.9	3.76	2	1.12	0.87	4.74	2.07	1.71	0.396	0.95	2.08		
			6		5.908	4.638	0.201	23.4	50	7.29	13.1	4.34	1.96	1.11	0.86	5.59	2.43	1.99	0.393	0.99	2.12		
75x50	75	50	7		6.802	5.339	0.201	26.5	58.1	8.24	15.5	4.97	1.98	1.1	0.86	6.4	2.78	2.29	0.389	1.03	2.15		
			4		4.553	3.57	0.226	23.2	45.9	7.55	12.3	4.4	2.26	1.29	0.98	4.86	2.17	1.77	0.41	1.02	2.24		
80x50	80	50	6	7.5	5.609	4.403	0.225	28	57.1	9.13	15.4	5.4	2.23	1.26	0.98	5.92	2.65	2.19	0.407	1.06	2.28		
			6		6.644	5.218	0.225	32.5	68.4	10.6	18.6	6.35	2.21	1.28	0.98	6.95	3.12	2.59	0.404	1.09	2.32		
80x50	80	50	7		7.658	6.011	0.225	37.2	80	12	21.8	7.16	2.2	1.25	0.97	8.03	3.57	2.94	0.402	1.13	2.36		
			5		6.126	4.808	0.245	34.9	70	12.5	21	7.41	2.39	1.44	1.1	6.83	3.3	2.74	0.435	1.17	2.4		
90x56	90	56	6	8	7.26	5.699	0.245	41.1	84.3	14.7	25.4	8.54	2.38	1.42	1.08	8.12	3.88	3.19	0.435	1.21	2.44		
			7		9.467	7.431	0.244	52.4	113	18.5	34.2	10.9	2.35	1.4	1.07	10.5	4.99	4.1	0.429	1.29	2.52		
90x56	90	56	10		11.59	9.098	0.244	52.7	141	22	43.4	13.1	2.33	1.38	1.06	12.8	6.04	4.99	0.423	1.36	2.6		
			5		6.376	5.005	0.255	42	85.2	12.8	21.1	7.66	2.56	1.42	1.1	7.78	3.32	2.74	0.388	1.14	2.6		
100x63	100	63	6	8	7.56	5.935	0.255	49.5	103	15	25.4	8.85	2.56	1.41	1.08	9.25	3.91	3.2	0.387	1.18	2.65		
			7		8.724	6.848	0.255	56.2	119	17	29.8	10.2	2.54	1.39	1.08	10.6	4.48	3.7	0.384	1.21	2.69		
100x63	100	63	8		9.867	7.745	0.254	62.8	136	18.9	34.3	11.4	2.52	1.38	1.07	11.9	5.03	4.16	0.381	1.25	2.73		
			5		7.212	5.661	0.287	60.5	121	18.3	29.5	11	2.9	1.59	1.28	9.92	4.21	3.49	0.385	1.25	2.91		
100x80	100	80	6	9	8.557	6.717	0.286	71	146	21.4	35.6	12.9	2.88	1.58	1.23	11.7	4.96	4.13	0.384	1.29	2.95		
			7		9.881	7.756	0.286	81	170	24.4	41.7	14.7	2.86	1.57	1.22	18.5	5.7	4.72	0.382	1.33	3		
100x80	100	80	8		11.18	8.779	0.285	91	194	27.2	47.9	16.3	2.85	1.56	1.21	15.3	6.41	5.29	0.38	1.36	3.04		
			6		9.618	7.55	0.32	99.1	200	30.9	50.5	18.4	3.21	1.79	1.38	14.6	6.35	5.25	0.394	1.43	3.24		
110x70	110	70	7	10	11.11	8.722	0.32	113	233	35.3	59.1	21	3.2	2.78	1.38	16.9	7.29	6.02	0.394	1.47	3.28		
			8		12.58	9.878	0.319	127	266	39.4	67.9	23.5	3.18	1.77	1.37	19.1	8.21	6.78	0.391	1.6	3.32		
110x70	110	70	10		15.47	12.142	0.319	154	333	47.1	85.7	28.3	3.16	1.74	1.35	23.3	9.98	8.24	0.387	1.58	3.3		
			6		10.64	8.35	0.354	107	200	61.2	103	31.7	3.17	2.4	1.72	15.2	10.2	8.37	0.627	1.97	2.95		
110x70	110	70	7	10	12.3	9.656	0.354	123	233	70.1	120	36.2	3.16	2.39	1.72	17.5	11.7	9.6	0.626	2.01	3		
			8		13.94	10.946	0.353	138	267	78.6	137	40.6	3.14	2.37	1.71	19.8	13.2	10.8	0.625	2.05	3.04		
110x70	110	70	10		17.17	13.476	0.353	167	334	94.7	172	49.1	3.12	2.35	1.69	24.2	16.1	13.1	0.622	2.13	3.12		
			6		10.64	8.35	0.354	133	266	42.9	69.1	25.4	3.54	2.01	1.54	17.9	7.9	6.53	0.403	1.57	3.53		
125x80	125	80	7	10	12.3	9.656	0.354	153	310	49	80.8	29	3.53	2	1.53	20.6	9.09	7.5	0.402	1.61	3.57		
			8		13.94	10.946	0.353	172	354	54.9	92.7	32.5	3.51	1.98	1.53	23.3	10.3	8.45	0.401	1.65	3.62		
125x80	125	80	10		17.17	13.476	0.353	208	443	65.9	117	39.2	3.48	1.96	1.51	28.5	12.5	10.3	0.397	1.72	3.7		
			7		14.1	11.066	0.403	228	455	74.4	120	43.8	4.02	2.3	1.76	26.9	12	9.92	0.408	1.8	4.01		
140x90	140	90	8	11	15.99	12.551	0.403	257	520	83.5	138	49.2	4.01	2.28	1.75	30.4	13.6	11.2	0.407	1.84	4.06		
			10		19.71	15.474	0.402	312	650	101	173	59.5	3.98	2.26	1.74	37.3	16.6	13.6	0.404	1.92	4.14		
140x90	140	90	12		23.35	18.33	0.402	364	780	117	210	69.4	3.95	2.24	1.72	44	19.4	16	0.4	2	4.22		
			8		18.04	14.16	0.453	366	731	121	196	70.8	4.5	2.59	1.98	38.5	17.3	14.3	0.411	2.04	4.5		
140x90	140	90	9		22.26	17.475	0.452	446	913	140	246	85.8	4.47	2.56	1.96	47.3	21.2	17.5	0.409	2.12	4.58		
			12		26.4	20.724	0.451	522	1100	170	297	100	4.44	2.54	1.95	55.9	25	20.5	0.406	2.19	4.66		
150x90	150	90	14		30.46	23.908	0.451	594	1280	192	349	114	4.42	2.51	1.94	64.2	28.5	23.5	0.403	2.27	4.74		
			8		18.84	14.8	0.473	442	898	123	196	74.1	4.84	2.55	1.98	43.9	17.5	14.5	0.364	1.97	4.92		
150x90	150	90	10	12	23.26	18.3	0.472	539	1120	149	246	89.9	4.81	2.53	1.97	54	21.4	17.7	0.362	2.05	5.1		
			12		27.6	21.7	0.471	632	1350	173	297	105	4.79	2.5	1.95	63.8	25.1	20.8	0.359	2.12	5.09		
160x100	160	100	14		31.86	25	0.471	721	1570	196	350	120	4.76	2.48	1.94	73.3	28.8	23.8	0.356	2.2	5.17		
			15		33.95	26.7	0.471	764	1680	207	376	127	4.74	2.47	1.93	78	30.5	25.3	0.354	2.24	5.1		
160x100	160	100	16		36.03	28.3	0.47	806	1800	217	403	134	4.73	2.45	1.93	82.6	32.3	26.8	0.352	2.27	5.25		
			10		25.32	19.872	0.512	669	1360														



热轧钢板

Hot-rolled Steel Sheet

中国标准 Chinese Standard: GB/T 709
材质 Grade: Q235B

厚度 Thickness mm	尺寸及理论重量 size mm & Mass kg/sh								
	1000x2000	1260x3000	1260x6000	1510x3000	1510x6000	1810x6000	1810x8000	2000L	2200L
1.2	18.84	35.61	71.22						
1.4	21.98	41.54	83.08						
1.5	23.55	44.51	89.02	53.34	106.68				
1.7	26.69	50.44	100.89	60.45	120.91				
1.8	28.26	53.41	106.82	64.01	128.02				
2.0	31.40	59.35	118.69	71.12	142.24				
2.25		66.76	133.53	80.01	160.02				
2.5		74.18	148.37	88.90	177.80				
2.75		81.60	163.20	97.79	195.58				
3.0		89.02	178.04	106.68	213.36				
3.25		96.44	192.87	115.57	231.14				
3.5		103.86	207.71	124.46	248.92				
3.75		111.27	222.55	133.35	266.70				
4.0		118.69	237.38	142.24	284.48				
4.25		126.11	252.22	151.13	302.26				
4.5		133.53	267.06	160.02	320.04				
4.75		140.95	281.89	168.91	337.82				
5.0		148.37	296.73	177.80	355.61				
5.25		155.78	311.57	186.69	373.39				
5.5		163.20	326.40	195.58	391.17				
5.75		170.62	341.24	204.47	408.95	490.19	653.59		
6.0		178.04	356.08	213.36	426.73	511.51	682.01		
7.0		207.71	415.42	248.92	497.85	596.76	795.68		
7.25		215.13	430.26	257.81	515.63	618.07	824.09		
7.5		222.55	445.10	266.70	533.41	639.38	852.51		
7.75		229.97	459.93	275.59	551.19	660.70	880.93		
8.0		237.38	474.77	284.48	568.97	682.01	909.34	125.6L	138.16L
9.25		274.48	548.95	328.93	657.87	788.57	1051.43	145.225L	159.7475L
9.5		281.89	563.79	337.82	675.65	809.88	1079.85	149.15L	164.065L
9.75		289.31	578.62	346.71	693.43	831.20	1108.26	153.075L	168.3825L
10.0		296.73	593.46	355.61	711.21	852.51	1136.68	157L	172.7L
11.25				400.06	800.11	959.07	1278.77	176.625L	194.2875L
11.5				408.95	817.89	980.39	1307.18	180.55L	198.605L
11.75				417.84	835.67	1001.70	1335.60	184.475L	202.9225L
12.0				426.73	853.45	1023.01	1364.02	188.4L	207.24L
13.5				480.07	960.13			211.95L	233.145L
13.75				488.96	977.91			215.875L	237.4625L
14.0				497.85	995.69			219.8L	241.78L
15.5				551.19	1102.38			243.35L	267.685L
15.75				560.08	1120.16			247.275L	272.0025L
16.0				568.97	1137.94			251.2L	276.32L
17.5				622.31	1244.62			274.75L	302.225L
18.0				640.09	1280.18			282.6L	310.86L
19.5				693.43	1386.86			306.15L	336.765L
19.75				702.32	1404.64			310.075L	341.0825L
20				711.21	1422.42			314L	345.4L
22								345.4L	379.94L
25								392.5L	431.75L
28								439.6L	483.56L
30								471L	518.1L
35								549.5L	604.45L
40								628L	690.8L

注1: 可通过“日盛钢铁”官方网站www.rising-steel.com或官方微信小程序了解产品详情及价格走势。



花纹板 Steel Floor Plate

中国标准 Chinese Standard: GB/T 709

材质 Grade: Q235B

厚度 Thickness mm	尺寸及理论重量 size mm & Mass kg/sh			
	1260x3000	1260x6000	1510x3000	1510x6000
1.8	64.94	129.88	77.83	155.65
2.0	70.88	141.75	84.94	169.88
2.25	78.29	156.59	93.83	187.66
2.5	85.71	171.42	102.72	205.44
2.75	93.13	186.26	111.61	223.22
3.0	100.55	201.10	120.50	241.00
3.25	107.97	215.93	129.39	258.78
3.5	115.38	230.77	138.28	276.56
3.75	122.80	245.61	147.17	294.34
4.0	130.22	260.44	156.06	312.12
4.25	137.64	275.28	164.95	329.90
4.5	145.06	290.12	173.84	347.68
4.75	152.48	304.95	182.73	365.46
5.0	159.89	319.79	191.62	383.24
5.25	167.31	334.62	200.51	401.02
5.5	174.73	349.46	209.40	418.80
5.75	182.15	364.30	218.29	436.58
6.0	189.57	379.13	227.18	454.36
7.0	219.24	438.48	262.74	525.48
7.25	226.66	453.32	271.63	543.26
7.5	234.08	468.15	280.52	561.04
7.75	241.49	482.99	289.41	578.82
8.0	248.91	497.83	298.30	596.60
9.25	286.00	572.01	342.75	685.50
9.5	293.42	586.85	351.64	703.28
9.75	300.84	601.68	360.53	721.06
10	308.26	616.52	369.42	738.84

低合金板 Steel Plate Q355(Q345)

中国标准 Chinese Standard: GB/T 709

材质 Grade: Q355B(Q345B)

厚度 Thickness mm	尺寸及理论重量 size mm & Mass kg/sh					
	1260x6000	1510x6000	1800L	2000L	2200L	2500L
2.5	148.37	177.80				
3	178.04	213.36				
4	237.38	284.48				
5	296.73	355.61				
6	356.08	426.73	84.78L	94.2L	103.62L	117.75L
8	474.77	568.97	113.04L	125.6L	138.16L	157L
10.0	593.46	711.21	141.3L	157L	172.7L	196.25L
12	712.15	853.45	169.56L	188.4L	207.24L	235.5L
14	830.84	995.69	197.82L	219.8L	241.78L	274.75L
16	949.54	1137.94	226.08L	251.2L	276.32L	314L
18.0	1068.23	1280.18	254.34L	282.6L	310.86L	353.25L
20	1186.92	1422.42	282.6L	314L	345.4L	392.5L
24			339.12L	376.8L	414.48L	471L
25.0			353.25L	392.5L	431.75L	490.625L
26			367.38L	408.2L	449.02L	510.25L
28			395.64L	439.6L	483.56L	549.5L
30.0			423.9L	471L	518.1L	588.75L
32			452.16L	502.4L	552.64L	628L
35.0			494.55L	549.5L	604.45L	686.875L
40			565.2L	628L	690.8L	785L
55			777.15L	863.5L	949.85L	1079.375L
60			847.8L	942L	1036.2L	1177.5L
70			989.1L	1099L	1208.9L	1373.75L
80			1130.4L	1256L	1381.6L	1570L
90			1271.7L	1413L	1554.3L	1766.25L
95			1342.35L	1491.5L	1640.65L	1864.375L
100			1413L	1570L	1727L	1962.5L
110			1554.3L	1727L	1899.7L	2158.75L
130			1836.9L	2041L	2245.1L	2551.25L



方矩管

Steel Square/Rectangular Tube

中国标准 Chinese Standard: GB/T 6728

材质 Grade: Q235B

标准长度 Length: 6m/12m

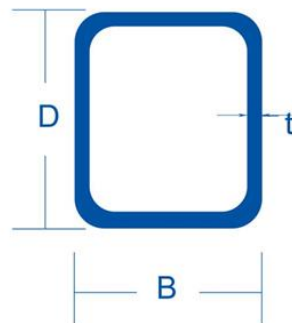

名称 Designation	规格Size mm	壁厚Thickness mm	名称 Designation	规格Size	壁厚Thickness mm
	DxB	t		DxB	t
方矩管 Steel Square Tub	20x20	1.0-3.0	矩形管 Steel Rectangular Tube	30x20	1.0-3.0
	25x25	1.0-3.0		40x20	1.0-3.75
	30x30	1.0-3.75		50x25	1.2-6.0
	40x40	1.2-6.0		50x30	1.2-6.0
	50x50	1.2-6.0		60x40	1.3-6.0
	60x60	1.3-6.0		80x40	1.3-6.0
	70x70	1.3-6.0		80x60	1.5-9.75
	80x80	1.3-6.0		100x50	1.5-9.75
	90x90	1.3-6.0		100x60	1.5-9.75
	100x100	1.5-15.75		100x80	1.5-9.75
	120x120	2.5-15.75		120x60	1.5-9.75
	125x125	2.5-15.75		120x80	1.5-9.75
	140x140	2.5-15.75		140x80	1.5-9.75
	150x150	2.5-15.75		150x100	2.5-15.75
	160x160	2.5-15.75		160x80	2.5-15.75
	180x180	2.5-15.75		200x100	2.5-15.75
	200x200	2.75-15.75		250x150	2.5-15.75
250x250	3.5-15.75	300x150	3.5-15.75		
300x300	4.5-15.75	300x200	3.5-15.75		
400x400	4.5-15.75	400x200	4.5-15.75		
500x500	4.5-15.75	400x300	4.5-15.75		

直缝焊管

Steel Welded Pipe

中国标准 Chinese Standard: GB/T 3091

材质 Grade: Q195、Q235B、Q355B(Q355B)

标准长度 Length: 6m/12m

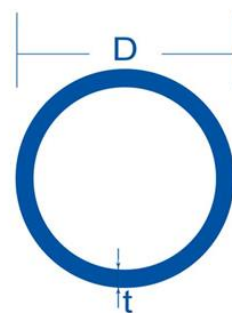

公称口径 DN mm	外径OD mm	尺寸	壁厚Thickness mm
	D		t
15	21.3	4分	0.7-2.75
20	26.9	6分	0.7-2.75
25	33.7	1寸	0.8-3.25
32	42.4	1.2寸	0.9-3.25
40	48.3	1.5寸	1.0-3.25
50	60.3	2寸	1.3-4.0
65	76.1	2.5寸	1.5-5.0
80	88.9	3寸	1.5-6.0
100	114.3	4寸	2.0-6.0
125	139.7	5寸	2.0-6.0
150	165.1	6寸	2.0-6.0
200	219.1	8寸	2.0-6.0



螺旋管

Steel Spiral-welded PIPE

中国标准 Chinese Standard: GB/T 3091

材质 Grade: Q235B、Q355B(Q355B)

标准长度 Length: 12m

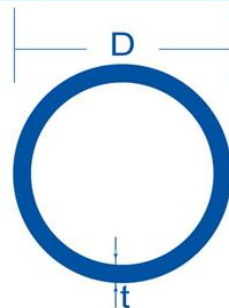

公称口径 DN mm	外径OD mm		壁厚Thickness mm	
	D		t	
200	219		5-10	
250	273		5-10	
300	325		5-12	
350	377		5-12	
400	426		5-12	
450	478		5-12	
500	529		5-16	
600	630		5-16	
700	720		6-18	
800	820		6-20	
900	920		6-20	
1000	1020		6-20	
1100	1120		6-20	
1200	1220		6-20	
1300	1320		8-20	
1400	1420		8-22	
1500	1520		8-25	
1600	1620		8-25	
1700	1720		10-25	
1800	1820		10-25	
1900	1920		10-25	
2000	2020		10-25	
2200	2220		10-25	
2400	2420		10-25	
2600	2620		10-25	

无缝管

Steel Seamless Pipe

中国标准 Chinese Standard: GB/T 3087

材质 Grade: 20#、45#、Q355B(Q345B)

标准长度 Length: 6m、不定尺 Random

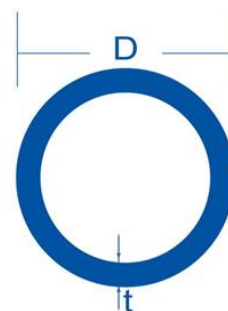

外径OD mm		壁厚Thickness mm		外径OD mm		壁厚Thickness mm	
D		t		D		t	
20		2-6		108		4-24	
22		2-8		114		4-24	
25		2-8		121		4-24	
27		2-8		127		4-24	
32		3-10		133		4-30	
34		3-12		140		4-30	
38		3-12		159		5-30	
42		3-14		168		5-30	
45		3-16		180		5-30	
48		3-16		219		5-30	
51		3-16		245		6-40	
57		3-16		273		6-40	
60		4-18		299		6-50	
63		4-18		325		8-45	
70		4-20		377		8-50	
73		4-20		426		10-50	
76		4-20		480		10-50	
83		4-20		530		10-50	
89		4-20		630		10-70	
102		4-22		720		20-100	

注1: 可通过“日盛钢铁”官方网站www.rising-steel.com或官方微信小程序了解产品详情及价格走势。



C型钢 Light Steel Channel

中国标准 Chinese Standard: GB/T 6725
材质 Grade: Q195、Q235B 镀锌 Gavanized
标准长度 Length: 6m

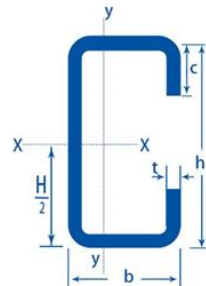

尺寸 Size mm	厚度 Thickness mm
hxb	
80x30	1.2-2
100x35	1.2-2
120x40	1.5-2.5
140x40	1.5-2.5
140x50	1.8-3.0
160x40	1.8-3.0
160x50	1.8-3.0
160x60	1.8-3.0
180x50	1.8-3.0
180x60	1.8-3.0
180x70	1.8-3.0
200x60	1.8-3.0
200x70	1.8-3.0
250x75	1.8-3.0
280x60	1.8-3.0

楼承板 Steel Floor Deck

材质 Grade: Q235B

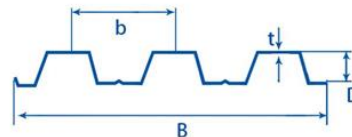

名称 Designation	规格 Size mm	肋高	波距	成型宽度	厚度
		Depth mm	Wave Width mm	Width mm	Thickness mm
		D	b	B	t
开口楼承板 Open Floor Deck	YX76-185-555	76	185	555	0.8/1.0/1.2
	YX76-293-3-880	76	293.3	880	0.8/1.0/1.2
	YX76-305-915	76	305	915	0.8/1.0/1.2
	YX76-320-960	76	320	960	0.8/1.0/1.2
	YX75-200-600	75	200	600	0.8/1.0/1.2
	YX75-230-690	75	230	690	0.8/1.0/1.2
	YX70-200-600	70	200	600	0.8/1.0/1.2
	YX51-250-750	51	250	750	0.8/1.0/1.2
	YX51-253-760	51	253	760	0.8/1.0/1.2
	YX51-305-915	51	305	915	0.8/1.0/1.2
闭口楼承板 Closed Floor Deck	YX51-340-1025	51	340	1025	0.8/1.0/1.2
	BD40-185-740	40	185	740	0.8/1.0/1.2
	BD40-200-800	40	200	800	0.8/1.0/1.2
	BD65-185-555	65	185	555	0.8/1.0/1.2
	BD65-170-510	65	170	510	0.8/1.0/1.2
	BD65-254-762	65	254	762	0.8/1.0/1.2
缩口板 Reducing End Deck	YX51-200-600	51	200	600	0.8/1.0/1.2
	YX51-283-3-850	51	283.3	850	0.8/1.0/1.2
	BD66-219-660	66	219	660	0.8/1.0/1.2
	BD66-240-720	66	240	720	0.8/1.0/1.2

注1: 可通过“日盛钢铁”官方网站www.rising-steel.com或官方微信小程序了解产品详情及价格走势。



钢轨

Steel Rail

中国标准 Chinese Standard: GB/T 11264
材质 Grade: Q235B、50Q、50Mn、U71Mn.

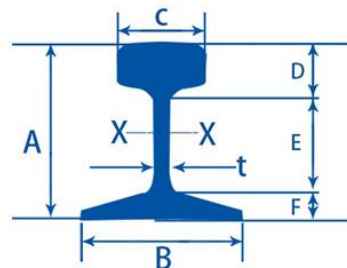

规格 Designation	高度 Depth mm	底部 Bottom Width mm	头宽 Top Width mm	腰厚 Web Thickness mm	理论重量 Mass kg/m	标准长度 Length m
	A	B	C	t		
6kg/m	51	50	26	5	5.98	6/8/10
8kg/m	65	54	25	7	8.42	6/8/10
9kg/m	63.5	63.5	32.1	5.9	8.94	6/8/10
12kg/m	69.85	69.85	38.1	7.54	12.2	6/8/10
15kg/m	79.37	79.37	42.86	8.33	15.2	6/8/10
18kg/m	90	80	40	10	18.06	6/8/10
22kg/m	93.66	93.66	50.8	10.72	22.3	6/8/10
24kg/m	107	92	51	10.8	24.46	6/8/10
30kg/m	107.95	107.95	60.33	12.3	30.1	6/8/10
38kg/m	134	114	68	13	38.733	12.5/25
43kg/m	140	114	70	14.5	44.653	12.5/25
50kg/m	152	132	70	15.5	51.514	12.5/25
60kg/m	176	150	73	16.5	60.64	12.5/25
Qu70	120	120	70	28	52.8	9-12.5
Qu80	130	130	80	32	63.69	9-12.5
Qu100	150	150	100	38	88.96	9-12.5
Qu120	170	170	120	44	118.1	9-12.5

钢板桩

Steel Sheet Pile

中国标准 Chinese Standard: GB/T 20933
材质 Grade: Q355B(Q345B)
标准长度 Length: 6m/9m/12m/15m/18m/24m

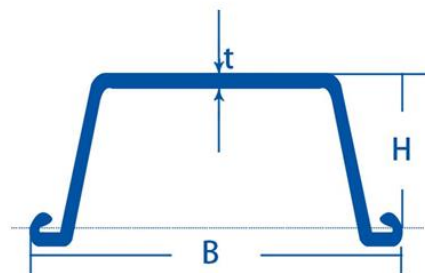

型号 Designation	截面尺寸 Size			理论重量 Mass kg/m	截面面积 Section Area m ²	截面模数	惯性矩
	宽度 Width mm	高度 Depth mm	腰厚 Thickness mm			Section Modulus cm ³	Moment of Inertia cm ⁴
	B	H	t			Z _x	I _x
2# U400x100	10.5	48	10.5	48	61.18	152	1240
3# U400x125	13	60	13	60	76.42	223	2220
4# U400x170	15.5	76.1	15.5	76.1	96.99	362	4670

注1: 可通过“日盛钢铁”官方网站www.rising-steel.com或官方微信小程序了解产品详情及价格走势。



扁钢

Steel Flat Bar

中国标准 Chinese Standard: GB/T 702

材质 Grade: Q235B

标准长度 Length: 6m



宽度 Width mm	厚度及理论重量 Thickness mm & Mass kg/pcs												
	t												
B	3	4	5	6	8	9	10	12	15	16	19	20	25
10	1.41	1.88	2.36	2.83	3.77	4.24	4.71	5.65	7.07	7.54	8.95	9.42	11.78
12	1.70	2.26	2.83	3.39	4.52	5.09	5.65	6.78	8.48	9.04	10.74	11.30	14.13
14	1.98	2.64	3.30	3.96	5.28	5.93	6.59	7.91	9.89	10.55	12.53	13.19	16.49
16	2.26	3.01	3.77	4.52	6.03	6.78	7.54	9.04	11.30	12.06	14.32	15.07	18.84
18	2.54	3.39	4.24	5.09	6.78	7.63	8.48	10.17	12.72	13.56	16.11	16.96	21.20
20	2.83	3.77	4.71	5.65	7.54	8.48	9.42	11.30	14.13	15.07	17.90	18.84	23.55
22	3.11	4.14	5.18	6.22	8.29	9.33	10.36	12.43	15.54	16.58	19.69	20.72	25.91
25	3.53	4.71	5.89	7.07	9.42	10.60	11.78	14.13	17.66	18.84	22.37	23.55	29.44
28	3.96	5.28	6.59	7.91	10.55	11.87	13.19	15.83	19.78	21.10	25.06	26.38	32.97
30	4.24	5.65	7.07	8.48	11.30	12.72	14.13	16.96	21.20	22.61	26.85	28.26	35.33
32	4.52	6.03	7.54	9.04	12.06	13.56	15.07	18.09	22.61	24.12	28.64	30.14	37.68
35	4.95	6.59	8.24	9.89	13.19	14.84	16.49	19.78	24.73	26.38	31.32	32.97	41.21
40	5.65	7.54	9.42	11.30	15.07	16.96	18.84	22.61	28.26	30.14	35.80	37.68	47.10
45	6.36	8.48	10.60	12.72	16.96	19.08	21.20	25.43	31.79	33.91	40.27	42.39	52.99
50	7.07	9.42	11.78	14.13	18.84	21.20	23.55	28.26	35.33	37.68	44.75	47.10	58.88
55	7.77	10.36	12.95	15.54	20.72	23.31	25.91	31.09	38.86	41.45	49.22	51.81	64.76
60	8.48	11.30	14.13	16.96	22.61	25.43	28.26	33.91	42.39	45.22	53.69	56.52	70.65
65	9.18	12.25	15.31	18.37	24.49	27.55	30.62	36.74	45.92	48.98	58.17	61.23	76.54
70	9.89	13.19	16.49	19.78	26.38	29.67	32.97	39.56	49.46	52.75	62.64	65.94	82.43
75	10.60	14.13	17.66	21.20	28.26	31.79	35.33	42.39	52.99	56.52	67.12	70.65	88.31
80	11.30	15.07	18.84	22.61	30.14	33.91	37.68	45.22	56.52	60.29	71.59	75.36	94.20
85	12.01	16.01	20.02	24.02	32.03	36.03	40.04	48.04	60.05	64.06	76.07	80.07	100.09
90	12.72	16.96	21.20	25.43	33.91	38.15	42.39	50.87	63.59	67.82	80.54	84.78	105.98
100	14.13	18.84	23.55	28.26	37.68	42.39	47.10	56.52	70.65	75.36	89.49	94.20	117.75
110	15.54	20.72	25.91	31.09	41.45	46.63	51.81	62.17	77.72	82.90	98.44	103.62	129.53
120	16.96	22.61	28.26	33.91	45.22	50.87	56.52	67.82	84.78	90.43	107.39	113.04	141.30
130	18.37	24.49	30.62	36.74	48.98	55.11	61.23	73.48	91.85	97.97	116.34	122.46	153.08
140	19.78	26.38	32.97	39.56	52.75	59.35	65.94	79.13	98.91	105.50	125.29	131.88	164.85
150	21.20	28.26	35.33	42.39	56.52	63.59	70.65	84.78	105.98	113.04	134.24	141.30	176.63
160	22.61	30.14	37.68	45.22	60.29	67.82	75.36	90.43	113.04	120.58	143.18	150.72	188.40
180	25.43	33.91	42.39	50.87	67.82	76.30	84.78	101.74	127.17	135.65	161.08	169.56	211.95
200	28.26	37.68	47.10	56.52	75.36	84.78	94.20	113.04	141.30	150.72	178.98	188.40	235.50

注1: 可通过“日盛钢铁”官方网站www.rising-steel.com或官方微信小程序了解产品详情及价格走势。



圆钢

Steel Round Bar

中国标准 Chinese Standard: GB/T 1499
 材质 Grade: Q235B
 标准长度 Length: 6m/9m

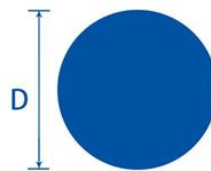

规格 Designation	直径 Diameter mm D	理论重量 Mass kg/m	规格 Designation	直径 Diameter mm D	理论重量 Mass kg/m
5.5#	5.5	0.187	45#	45	12.494
6#	6	0.222	48#	48	14.216
6.5#	6.5	0.261	50#	50	15.425
7#	7	0.302	53#	53	17.332
8#	8	0.395	55#	55	18.664
9#	9	0.500	56#	56	19.349
10#	10	0.617	58#	58	20.756
11#	11	0.747	60#	60	22.212
12#	12	0.888	63#	63	24.489
13#	13	1.043	65#	65	26.068
14#	14	1.209	68#	68	28.530
15#	15	1.388	70#	70	30.233
16#	16	1.580	75#	75	34.706
17#	17	1.783	80#	80	39.488
18#	18	1.999	85#	85	44.578
19#	19	2.227	90#	90	49.977
20#	20	2.468	95#	95	55.684
21#	21	2.721	100#	100	61.700
22#	22	2.986	105#	105	68.024
23#	23	3.264	110#	110	74.657
24#	24	3.554	115#	115	81.598
25#	25	3.856	120#	120	88.848
26#	26	4.171	130#	130	104.273
27#	27	4.498	140#	140	120.932
28#	28	4.837	150#	150	138.825
29#	29	5.189	160#	160	157.952
30#	30	5.553	170#	170	178.313
31#	31	5.929	180#	180	199.908
32#	32	6.318	190#	190	222.737
33#	33	6.719	200#	200	246.800
34#	34	7.133	210#	210	272.097
35#	35	7.558	220#	220	298.628
36#	36	7.996	230#	230	326.393
38#	38	8.909	240#	240	355.392
40#	40	9.872	250#	250	385.625
42#	42	10.884	260#	260	417.092

注1: 可通过“日盛钢铁”官方网站www.rising-steel.com或官方微信小程序了解产品详情及价格走势。

GEOGRAPHIC MAP

公司产业地理图



佛山市日盛钢铁贸易有限公司

总公司地址：广东省佛山市顺德区乐从镇建设路 B277 号

分公司地址：

- E 区分公司（销售门市）：佛山市顺德区乐从钢铁世界商务楼 B 座 110-112 号
- C 区分公司（销售门市）：佛山市顺德区乐从钢铁世界 C3 区钢铁世界南路 15 号
- E 区仓库：佛山市顺德区乐从镇钢铁世界 E2 区西三路 03-04 号
- C 区仓库：佛山市顺德区乐从镇钢铁世界 C3 区钢铁世界南路
- C 区 2 仓库：佛山市顺德区乐从镇钢铁世界 C4 区西环路 10 号

服务热线：4008-335-228

投诉热线：13923231308

传真：0757-28855122

官方网站：<http://www.rising-steel.com>

E-mail: rs@fsrsheng.cn

湖北日盛科技有限公司（特钢厂）

地址：湖北省大冶市灵乡镇灵成工业园

电话：0714-8477888

传真：0714-8477889

邮箱：DYRS168@SINA.COM

周经理：18972799888

日盛科技（特钢销售公司）

地址：佛山市顺德区北滘镇马龙村三乐路公路边龙涌路口东侧
华地五金产业园 B1

电话：0757-23837288

传真：0757-2383768

网址：www.risingsteel.com

陈经理：13923235477